



Technical Data

Immersible Coolant Pump - SPC 8-25

Revision no.

 Page:
1

Receiver

From

 Company name
 Respons. Department
 Person in charge
 Phone number
 Fax no
 E-mail address



Brand: Gol Pumps
Model: SPC 8-25

Frequency	60 Hz
Enclosure Class	IP54
Insulation Class	F
Liquid Temp. Range	+32 °F ~ +194 °F
Max. Ambient Temp.	+104 °F
Max. Operating Pressure	142 PSI
Liquid Viscosity	1 ~ 32 cSt

Dimensions:

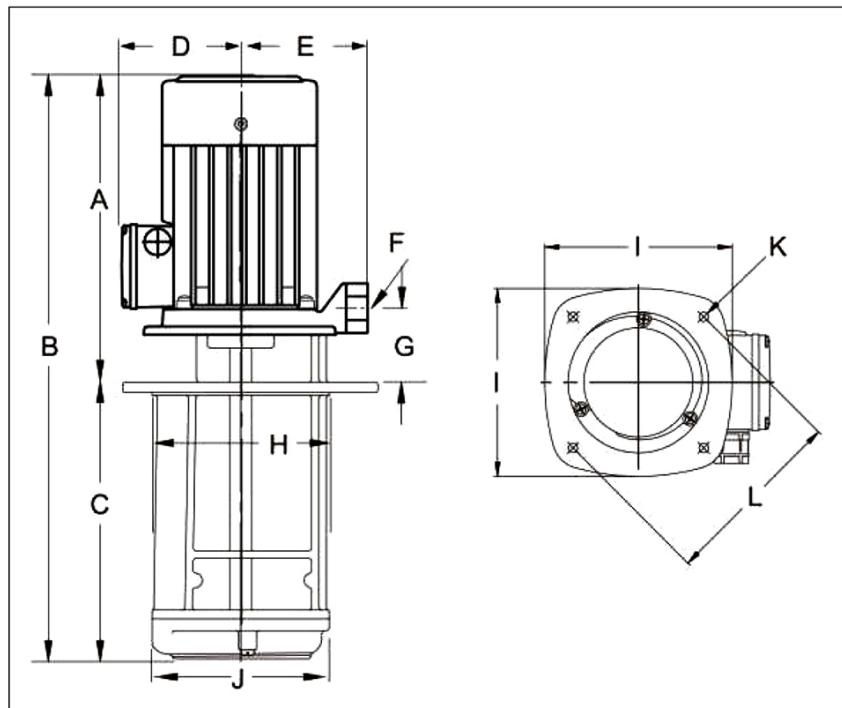

Pump Installation Size (inch)													Weight
Outlet	A	B	C	D	E	F	G	H	I	J	K	L	lb
RP 1	10.6	20.5	9.8	4.5	3.7	RP 1	1.2	5.1	7.5	5.9	4-Ø0.3	PCD 7.3	33.4

Project

Project ID

Created by

Created on

Last update



Performance Curve

Immersible Coolant Pump - SPC 8-25

Revision no.

Page:
2

Receiver

From

Company name
 Respons. Department
 Person in charge
 Phone number
 Fax no
 E-mail address

Model	Capacity			Head		Speed	Motor	Voltage	Phase	Amps
	m ³ /h	l/m	gpm	m	ft	r/min	hp	v		
SPC 8-25	17.5	290	76.6	16.5	54.1	3500	1.6	460	3	2.1

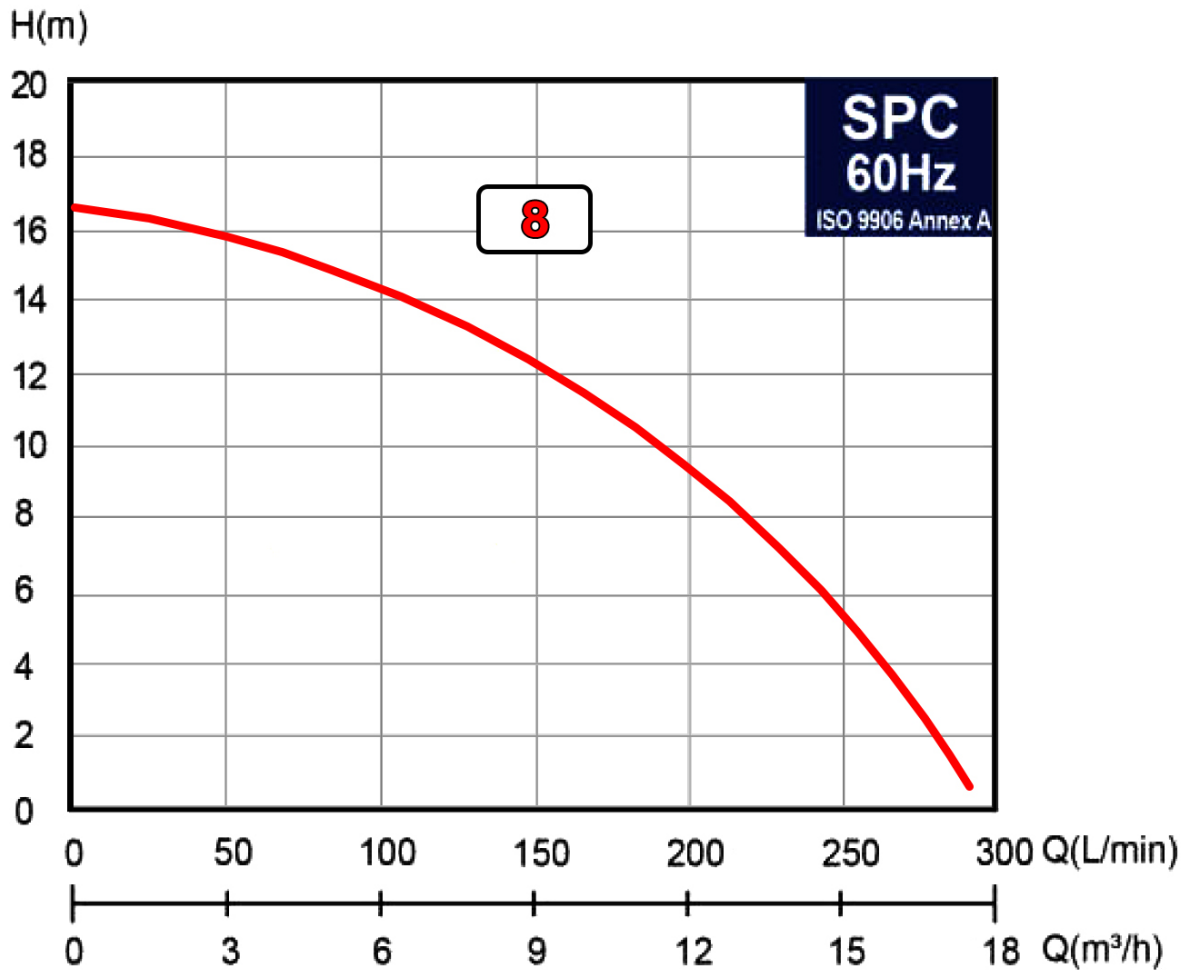

Project	Project ID	Created by	Created on	Last update
---------	------------	------------	------------	-------------



Parts and Materials

Immersible Coolant Pump - SPC 8-25

Revision no.

Page:
3

Receiver

From

Company name
Respons. Department
Person in charge
Phone number
Fax no
E-mail address

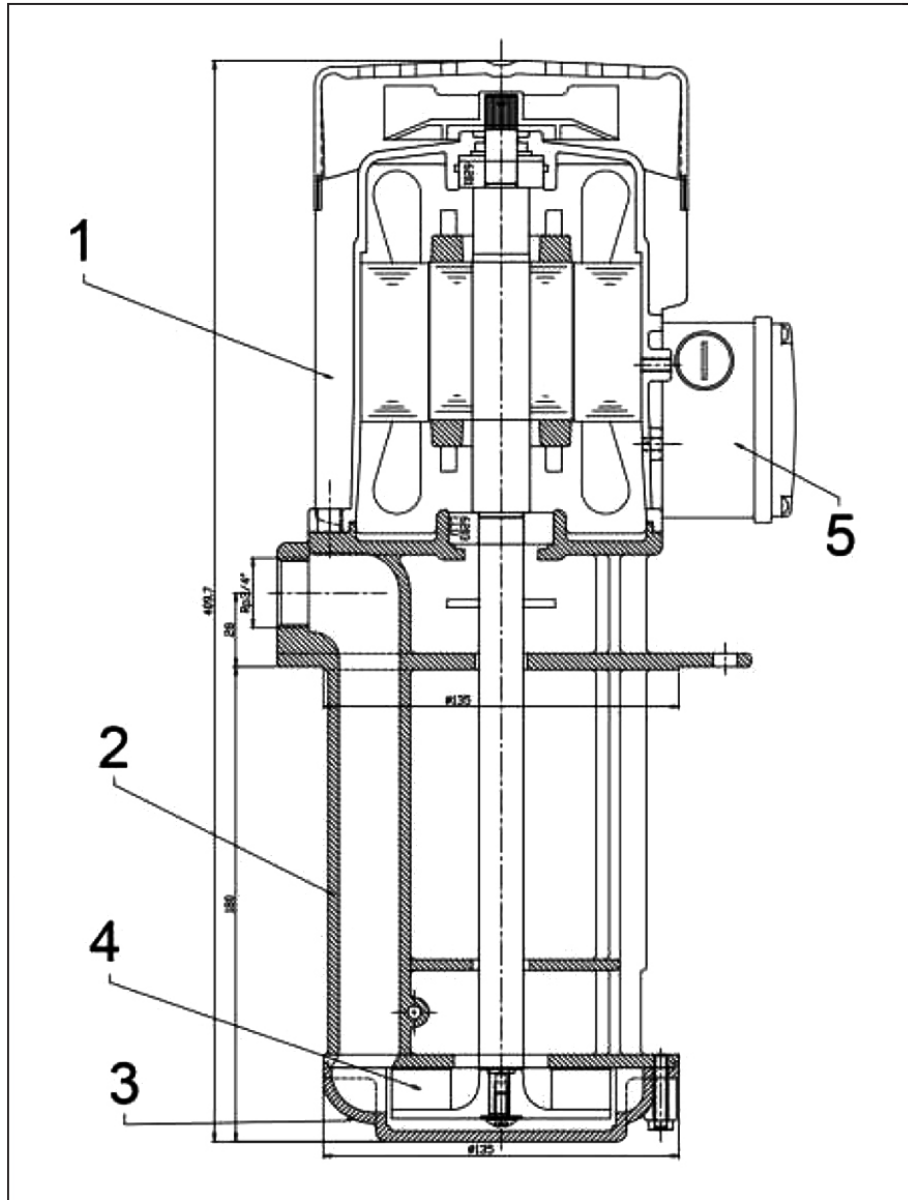

No	Component	Material
1	Motor	ADC 12
2	Pump	FC 20
3	Pump Cover	FC 20
4	Impeller	Nylon
5	Wiring Box	ABS

Project

Project ID

Created by

Created on

Last update



Installation

Immersible Coolant Pump - SPC 8-25

Revision no.

Page:
4

Receiver

From

Company name
Respons. Department
Person in charge
Phone number
Fax no
E-mail address

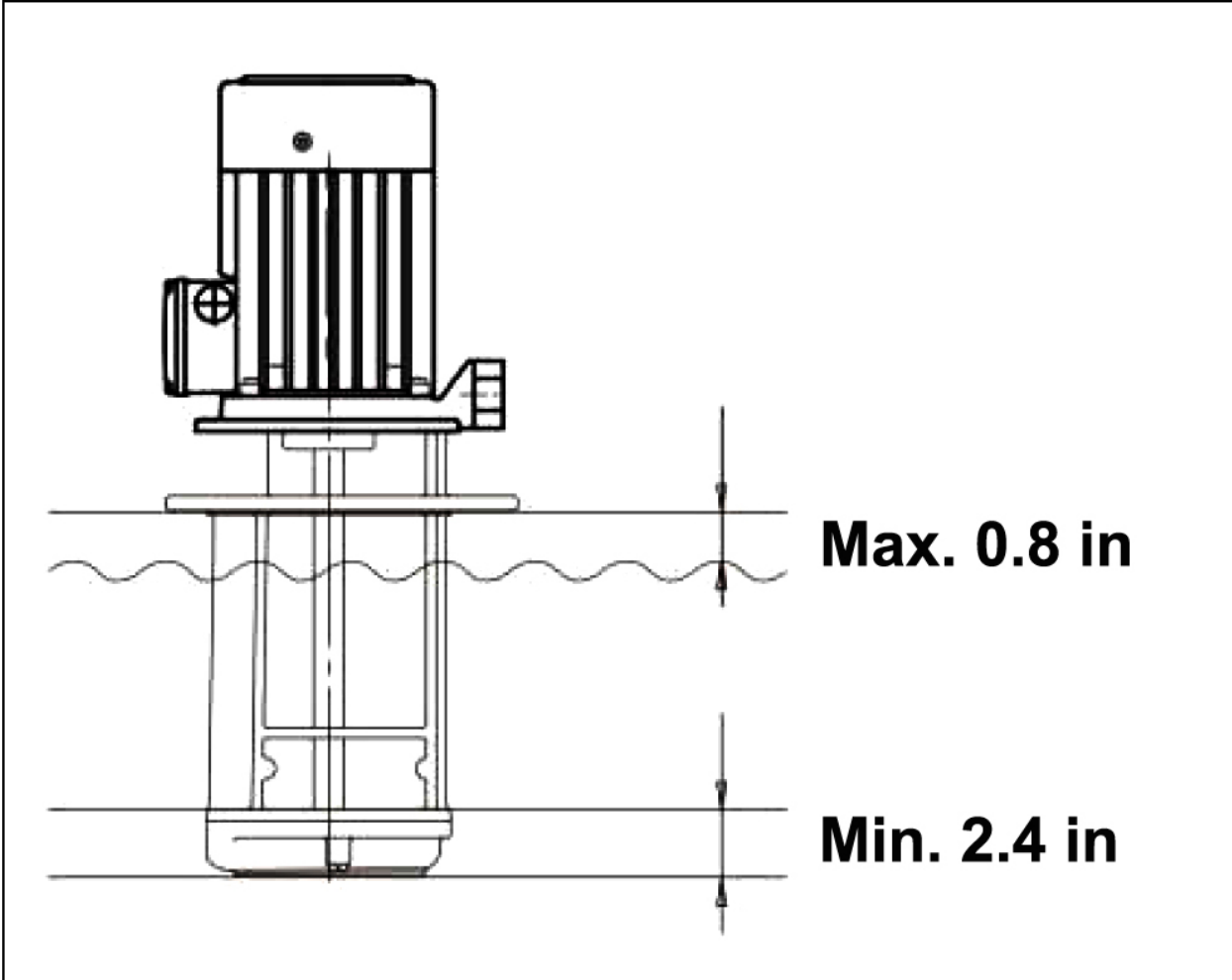

Project

Project ID

Created by

Created on

Last update